

LTE / 4G / 3G / 2G

WCDMA/GSMCDMA

NB-IOT SMD ANTENNA

824-960MHz, 1710-2700MHz

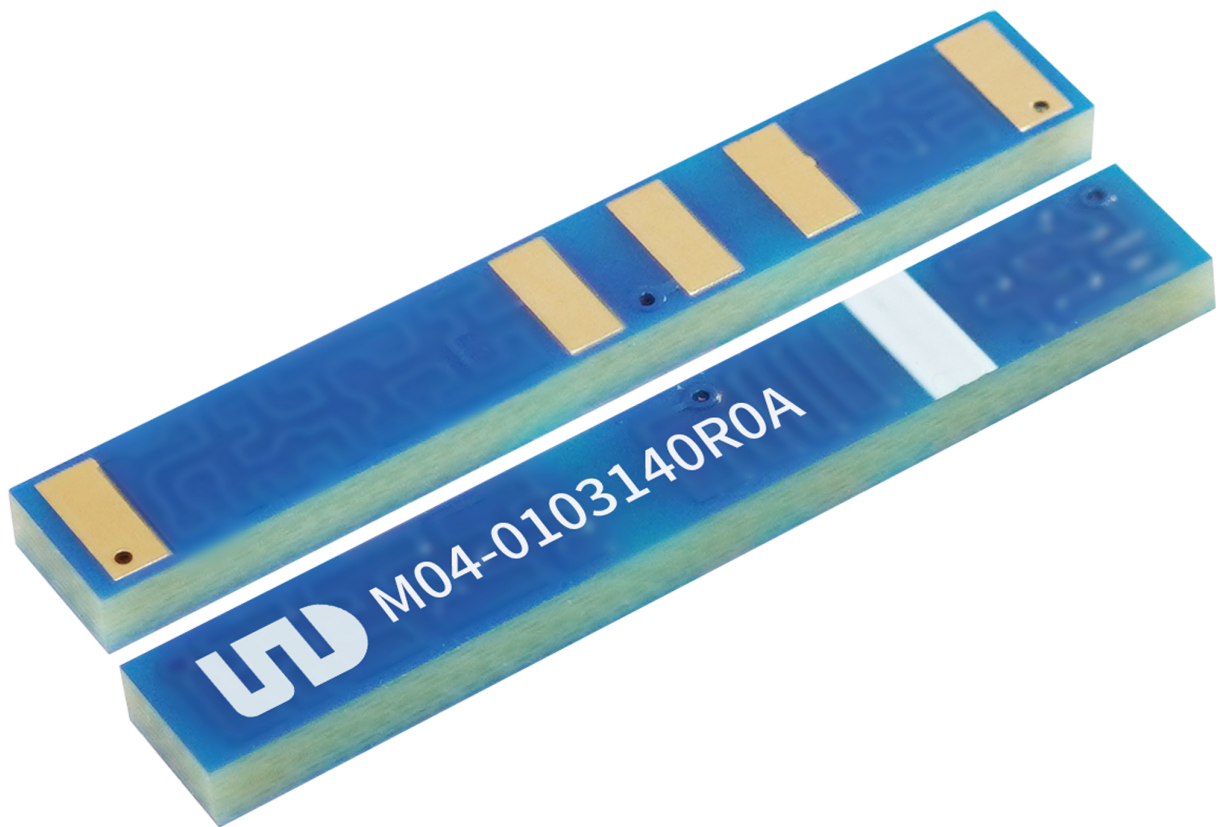

Model: ADCH002

Part Number: M04-0103140R0A



1 FEATURES & BENEFITS

✓ **Low Profile**

Being small and lightweight, this embedded antenna can be easily integrated into mobile devices without occupying excessive space.

✓ **Low Cost**

By axing design fees, this standard antenna opens the door to mass production, slashing overall product costs.

✓ **Easy to Integrate**

Available to seamlessly integrate with other circuit components, simplifying the circuit board's complexity and enhancing the reliability of the entire system.

✓ **Reduced Time-to-Market**

Development efficiency improves by shortening the cycle time associated with a custom solution, getting products to market faster.

2 APPLICATIONS

- ✓ Mobile Devices
- ✓ Wireless Routers and Modems
- ✓ Internet of Things (IoT) Devices, M2M
- ✓ Remote Technology / Monitoring
- ✓ Consumer Tracking
- ✓ Smart Metering

3 SPECIFICATIONS

3.1 General Information

Product Name	LTE/4G/3G/2G/WCDMA/ GSM/CDMA/NB-IoT SMD ANTENNA
Part Number	M04-0103140R0A
Mounting	SMT
Weight	0.3g
Dimensions	23 x 3.5 x 1.6 mm
Color	Blue
Antenna Type	SMD
Packaging	Tape & Reel

3.2 Environmental Conditions

Operating Temperature	-40°C to +85°C
Storage Temperature	-40°C to +80°C
Storage Temperature (Antenna with packing sealed)	-5°C to +40°C
Relative Humidity	10 to 70%

3.3 Certification

RoHS Approval	Compliant [2011/65/EU&2015/863]
REACH Approval	Conform or declared [(EC)1907/2006]
Hazardous material regulation conformance: A certificate of conformance is available upon request. Feel free to consult us for details.	

3.4 Electrical Properties

Frequency Range	824-960MHz	1710-2700MHz
VSWR	<3.5	
Peak Gain	3.3 dBi (824-960MHz)	
	2.0 dBi (1710-2170MHz)	
	2.0 dBi (2300-2700Mhz)	
Power Capacity	4W	
Input Impedance	50 Ω	
<p>All data were measured in free space and on a reference ground plane of 60 mm length, 40 mm width, and 1.0 mm thickness. Application data might vary. Data given for the 824-960, 1710-2700 MHz frequency ranges.</p>		

4 ANTENNA DIMENSIONS

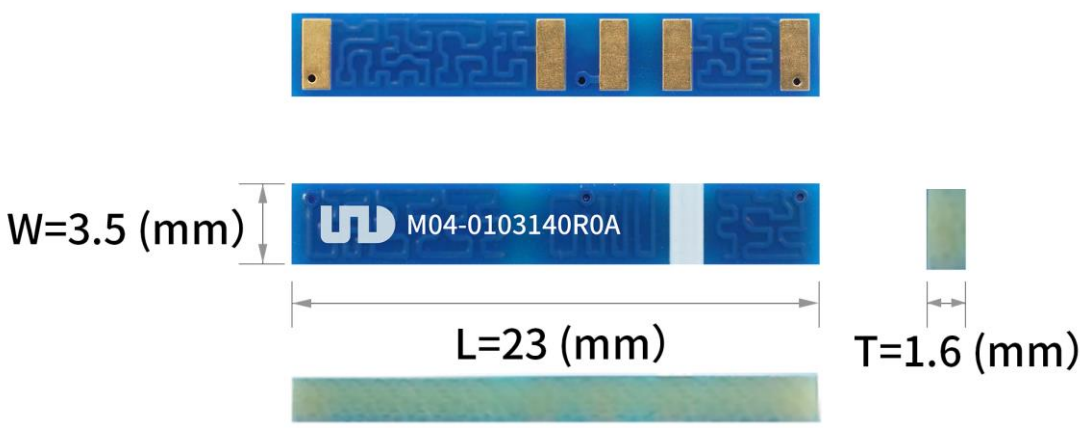

The diagram shows three views of the antenna: a top view of the blue PCB with gold pads, a side view showing the width (W=3.5 mm) and length (L=23 mm), and a front view showing the thickness (T=1.6 mm). The PCB is labeled with the MyAntenna logo and the part number M04-0103140R0A.

Items	Dimensions (mm)
L	23.0±0.2
w	3.5±0.1
T	1.6±0.1

5 MOUNTING GUIDE

5.1 Antenna Pad and Circuit Design

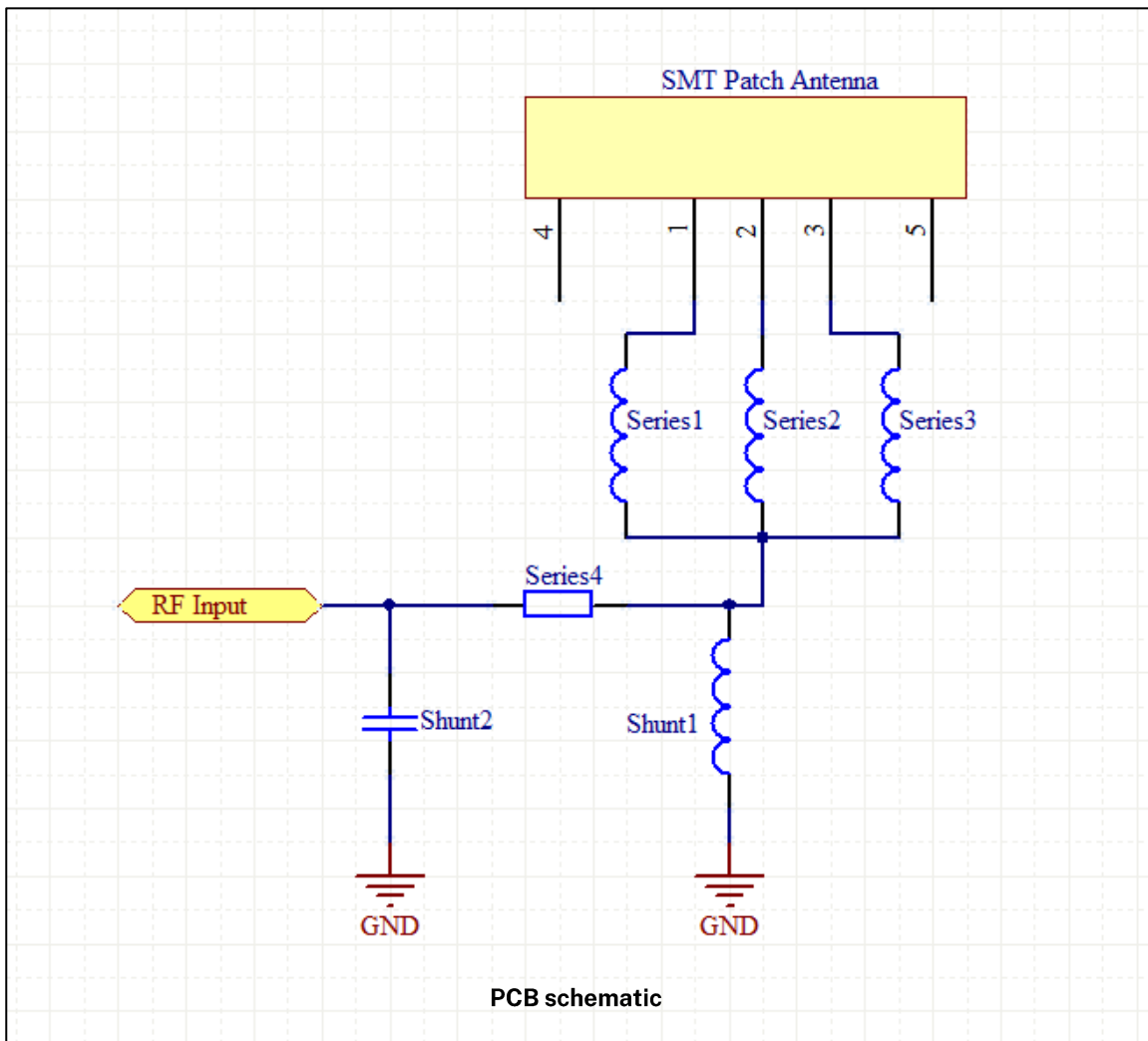

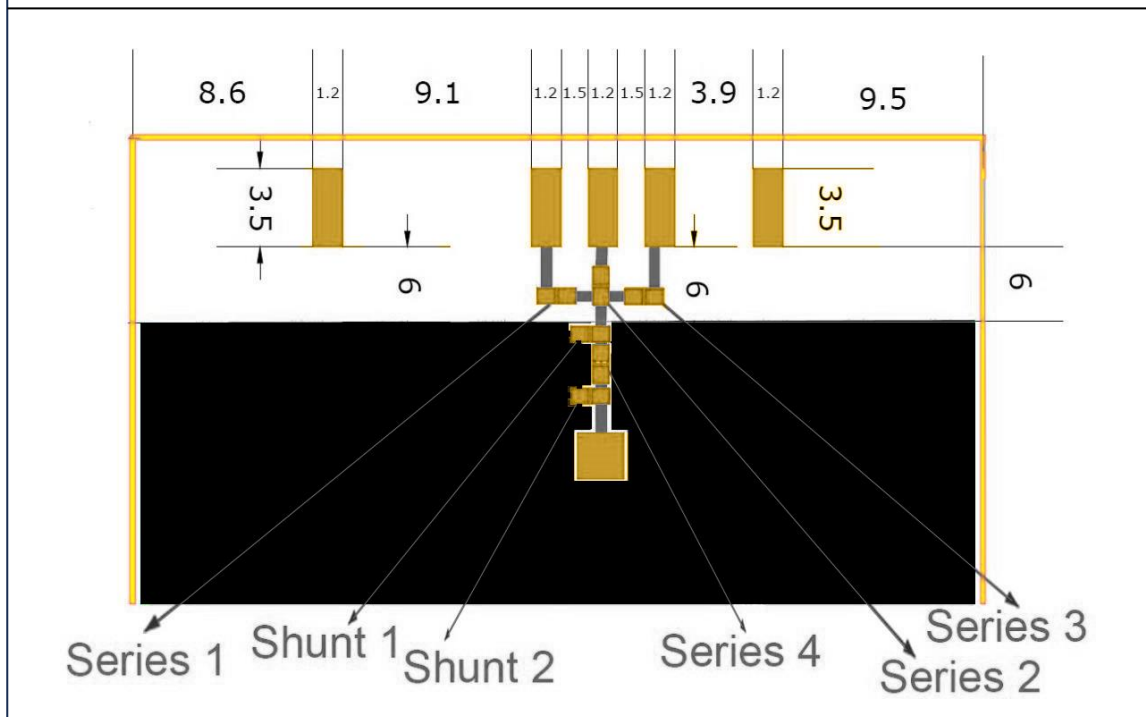
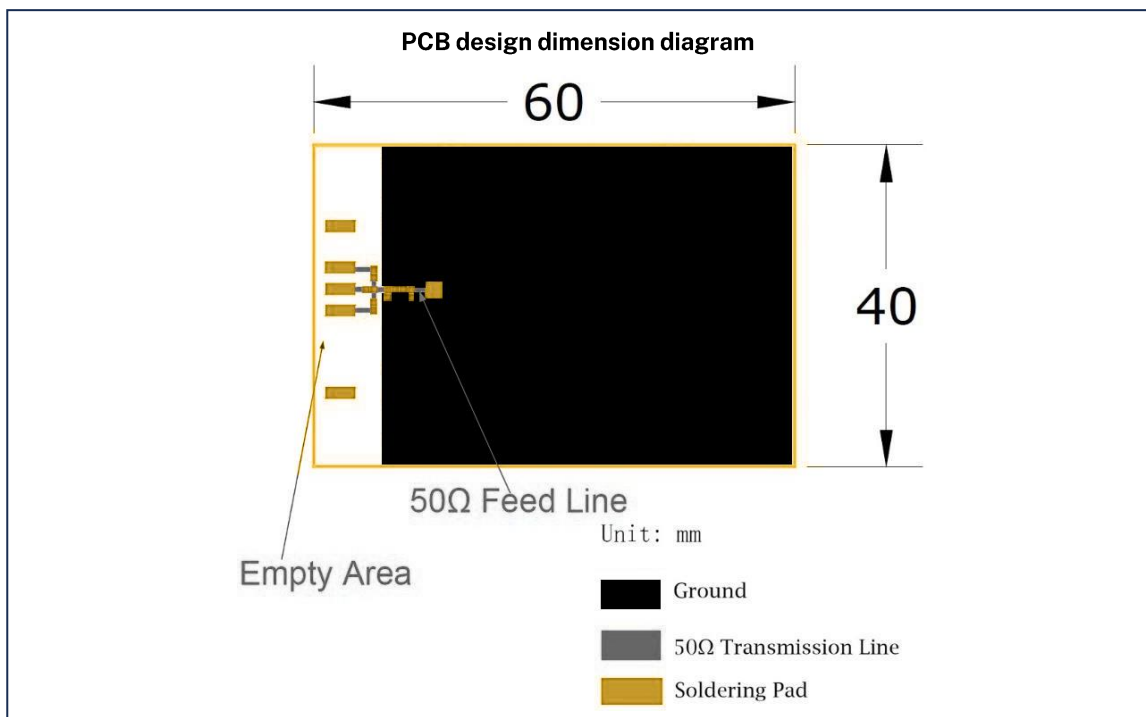

Matching component values	Series component Series 1	High frequency inductor 22nh
	Series component Series 2	High frequency inductor 2.2nh
	Series component Series 3	High frequency inductor 4.3nh
	Parallel component Shunt 1	High frequency inductor 18nh
	Series component Series 4	Impedance 0Ω
	Parallel component Shunt 2	Leave empty NC

5.2 The Evaluation Board with Antenna

The evaluation board has been designed for evaluation purposes of 824-960 MHz /1710-2700 MHz.

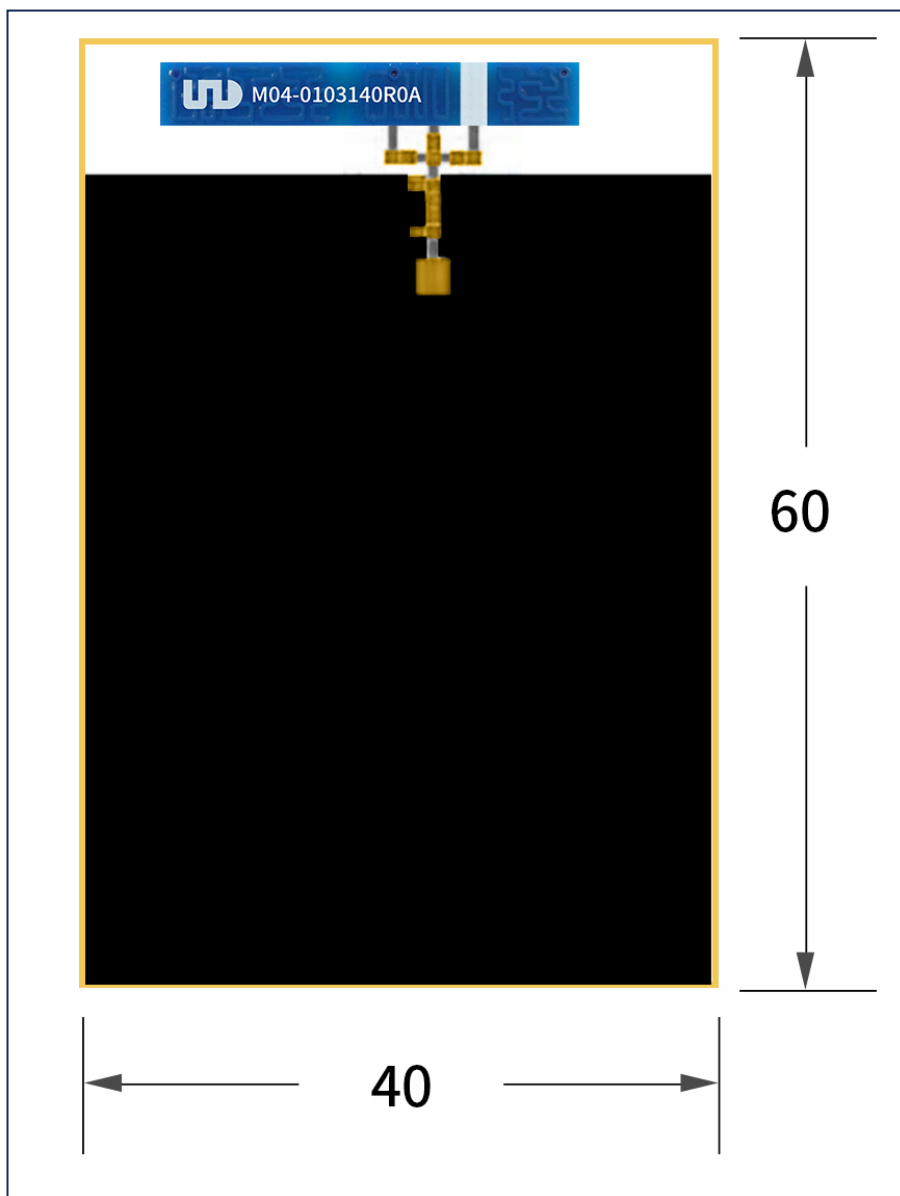

Evaluation Board dimension : 60 x 40 x 1.0 mm

5.3 Soldering Conditions

This antenna is suitable for lead free soldering.

The reflow duration should be adjusted to create good solder joints without raising the antenna temperature beyond the allowed maximum of 260°C.

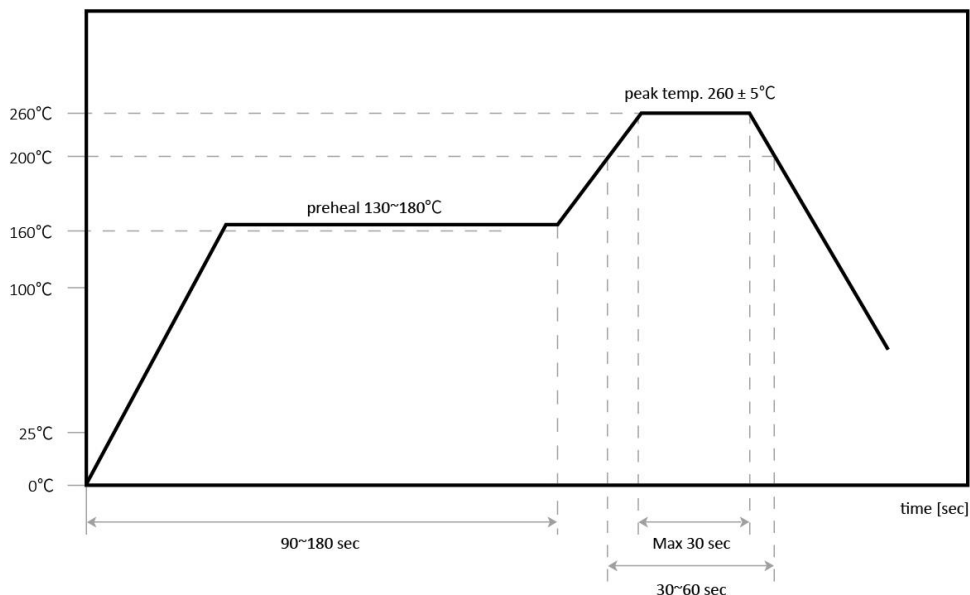

6 ELECTRICAL PERFORMANCE

Note: All data displayed in Chapter 6 were measured in free space and on a reference ground plane of 60 mm length, 40 mm width, and 1.0 mm thickness.

6.1 Return Loss (dB)

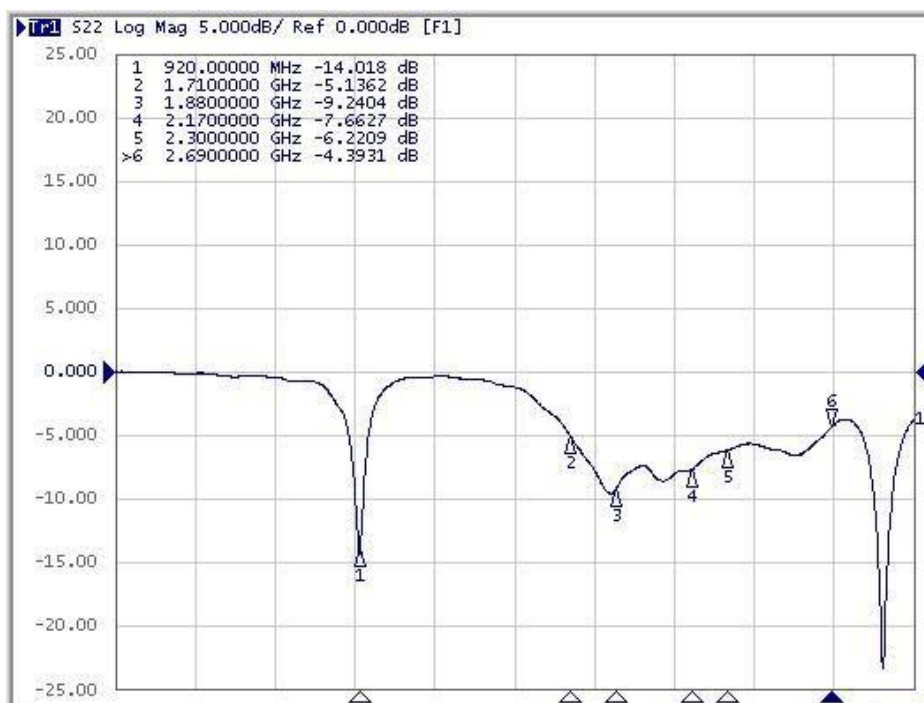

6.2 VSWR

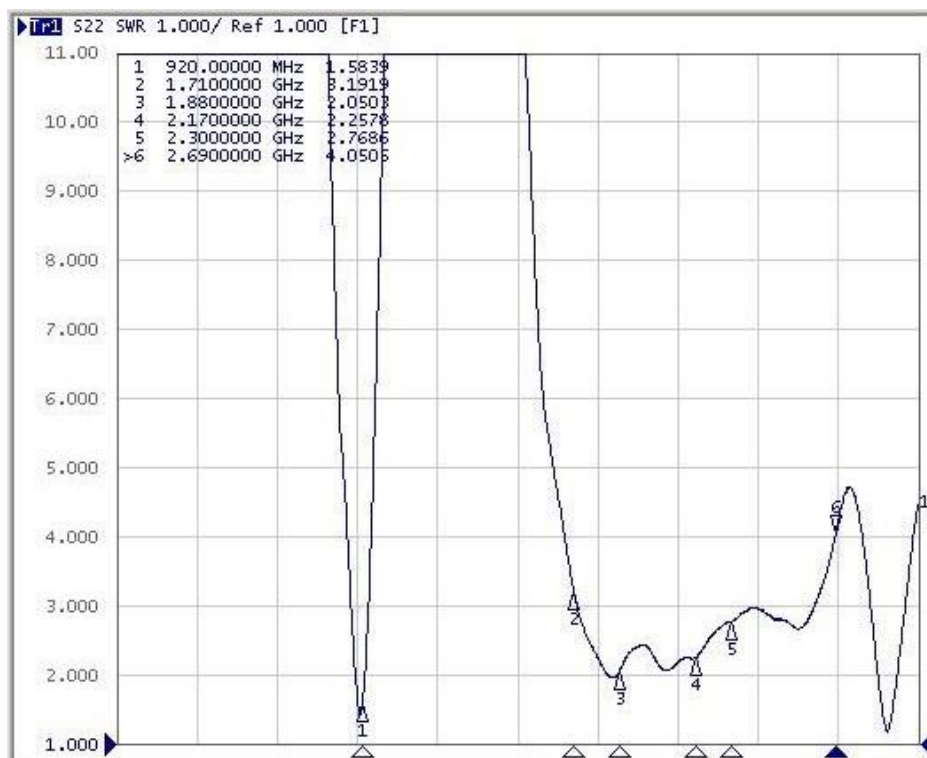

6.3 Efficiency (%) and Peak Gain (dBi)

Peak Gain & Efficiency	824-960MHz	1710-2170MHz	2300-2700Mhz
Peak Gain	3.36dBi	2.0dBi	2.0dBi
Average Gain across the band	1.71dBi	0.377dBi	0.39dBi
Gain Range across the band	-0.64dBi ~ 3.36dBi	-3.68dBi ~ 2.0dBi	-3.8dBi ~ 2.0dBi
Peak Efficiency	20.0%	52.8%	50.5%
Average Efficiency across the band	15.8%	40.1%	37.6%
Efficiency Range across the band	8.0% ~ 20.0%	17.2% ~ 52.8%	8.2% ~ 50.5%

LTE Efficiency (824-960MHz, 1710-2170MHz, 2300-2690MHz)

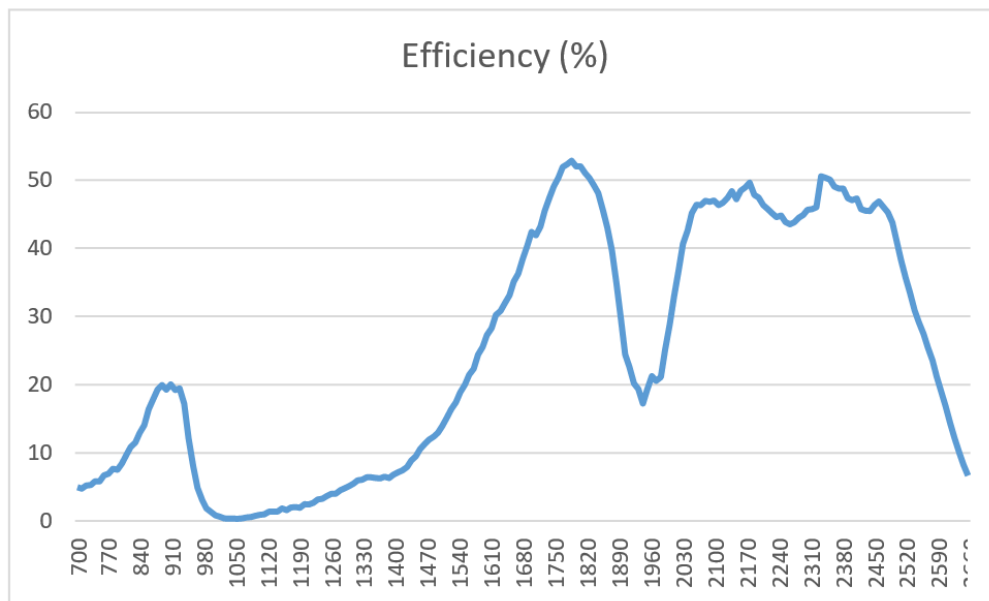

6.4 Radiation Pattern

The M04-0103140R0A antenna's radiation plots are obtained based on the test PCB board size and the test direction shown in the figure below.

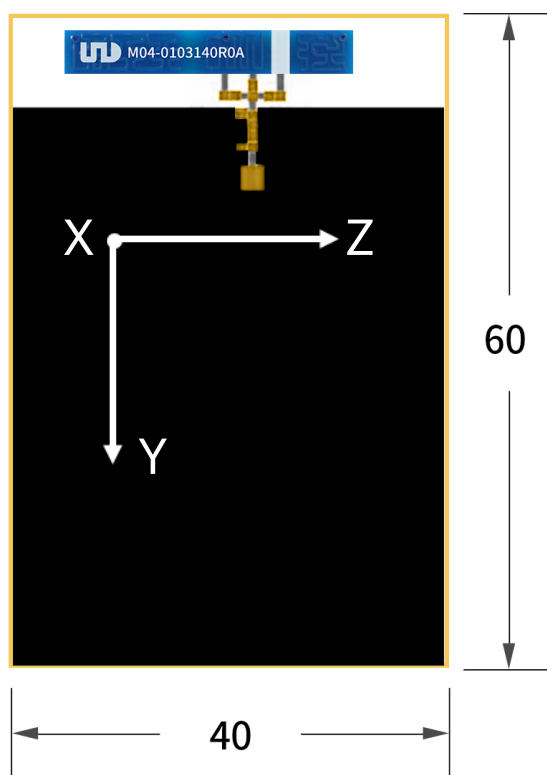

Unit: mm
Thickness: 1.0 mm

**Theta
@920 MHz**

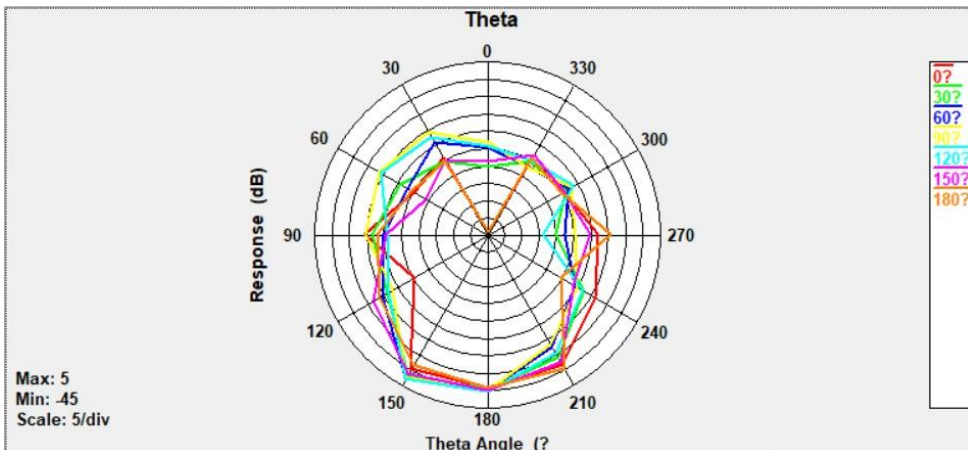

**Phi
@920 MHz**

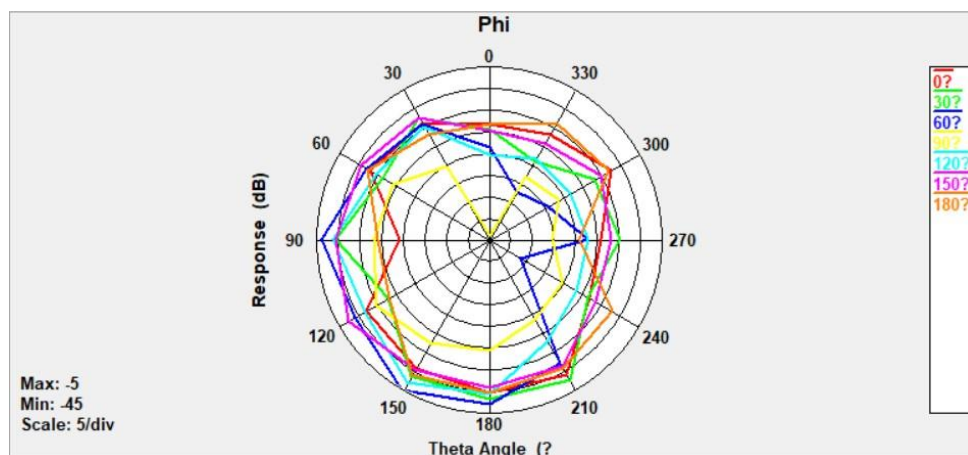

**Total
@920 MHz**

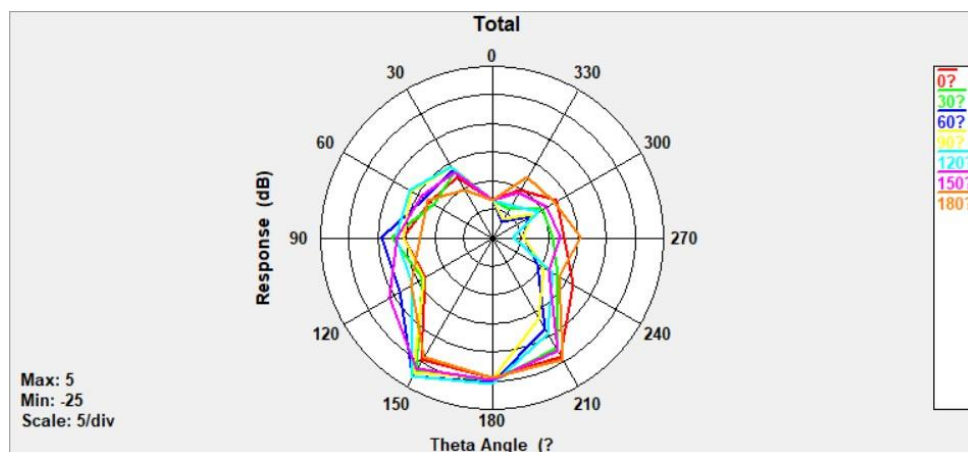

**Theta
@1800 MHz**

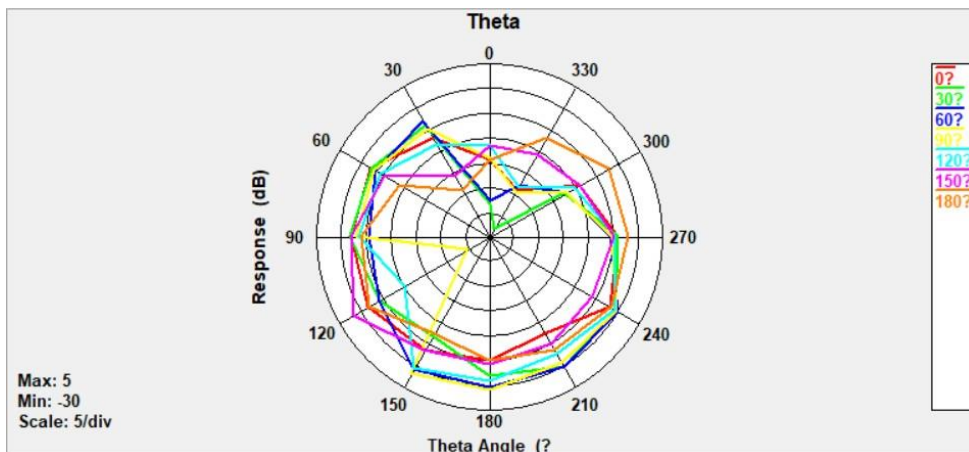

**Phi
@1800 MHz**

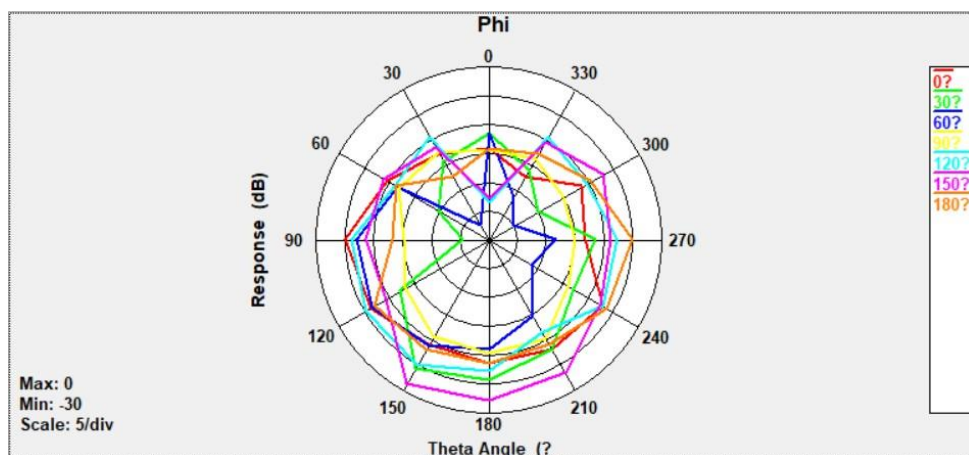

**Total
@1800 MHz**

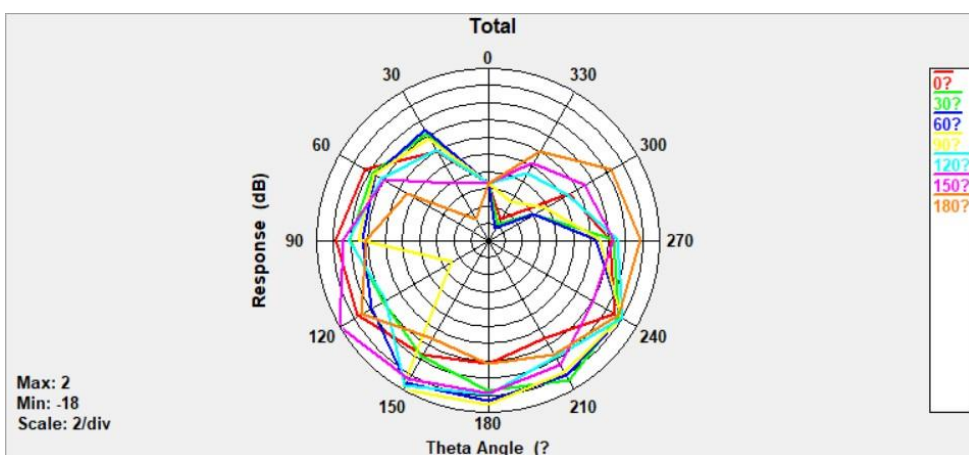

Theta
@2500 MHz

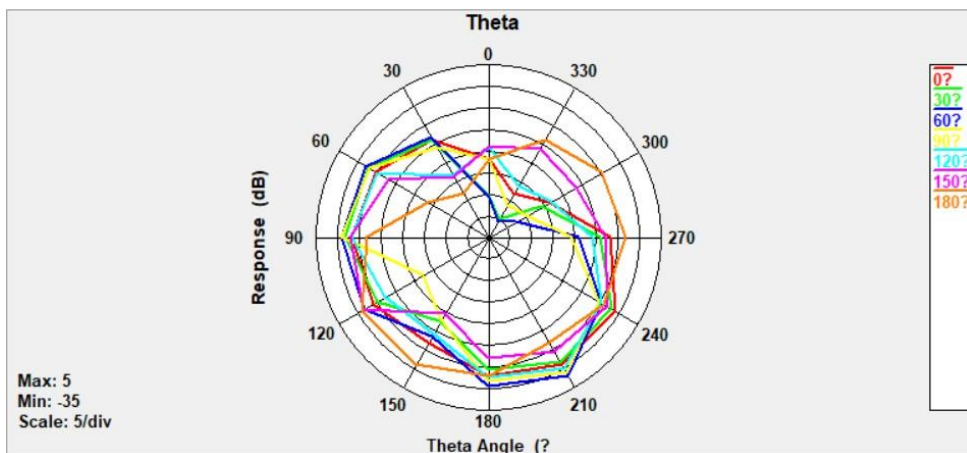

Phi
@2500 MHz

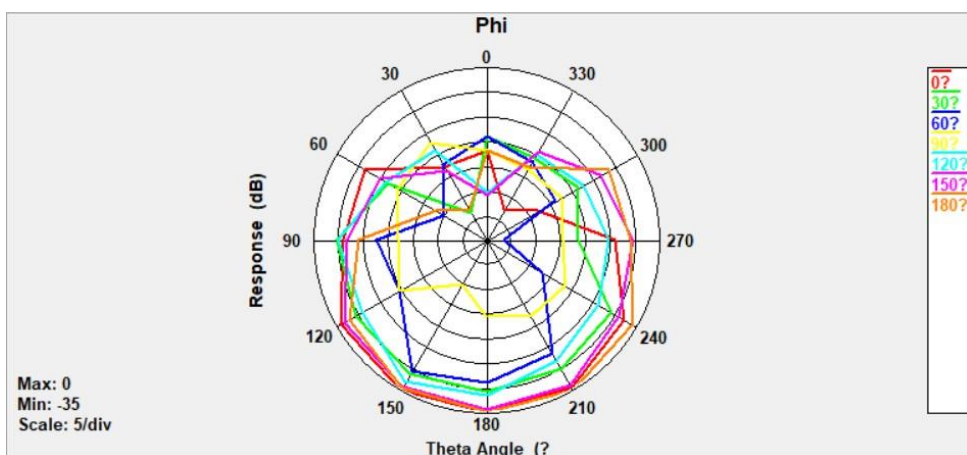

Total
@2500 MHz

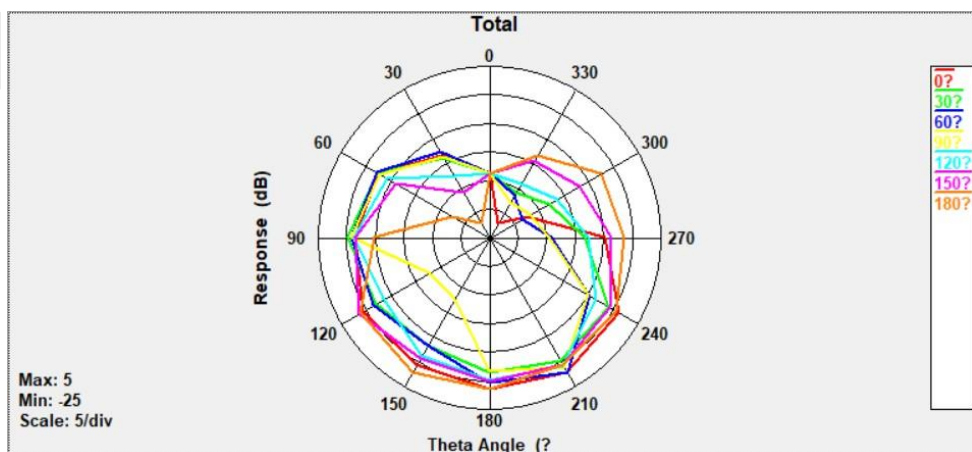

7 PACKAGING

7.1 Optimal Storage Conditions for Packaged Reels

Temperature	-5°C to 40°C
Humidity	Less than 70% RH
Shelf life	18 months
Storage place	Away from corrosive gas and direct sunlight
Packaging	Reels should be stored in unopened sealed manufacturer's plastic packaging.

Note: Storage of open reels of antennas is not recommended due to possible oxidization of pads on antennas. If short-term storage is necessary, then it is highly recommended that the bag containing the antenna reel is re-sealed and stored in like storage conditions as in the above table.

7.2 Packagings and Dimensions (Unit: mm)

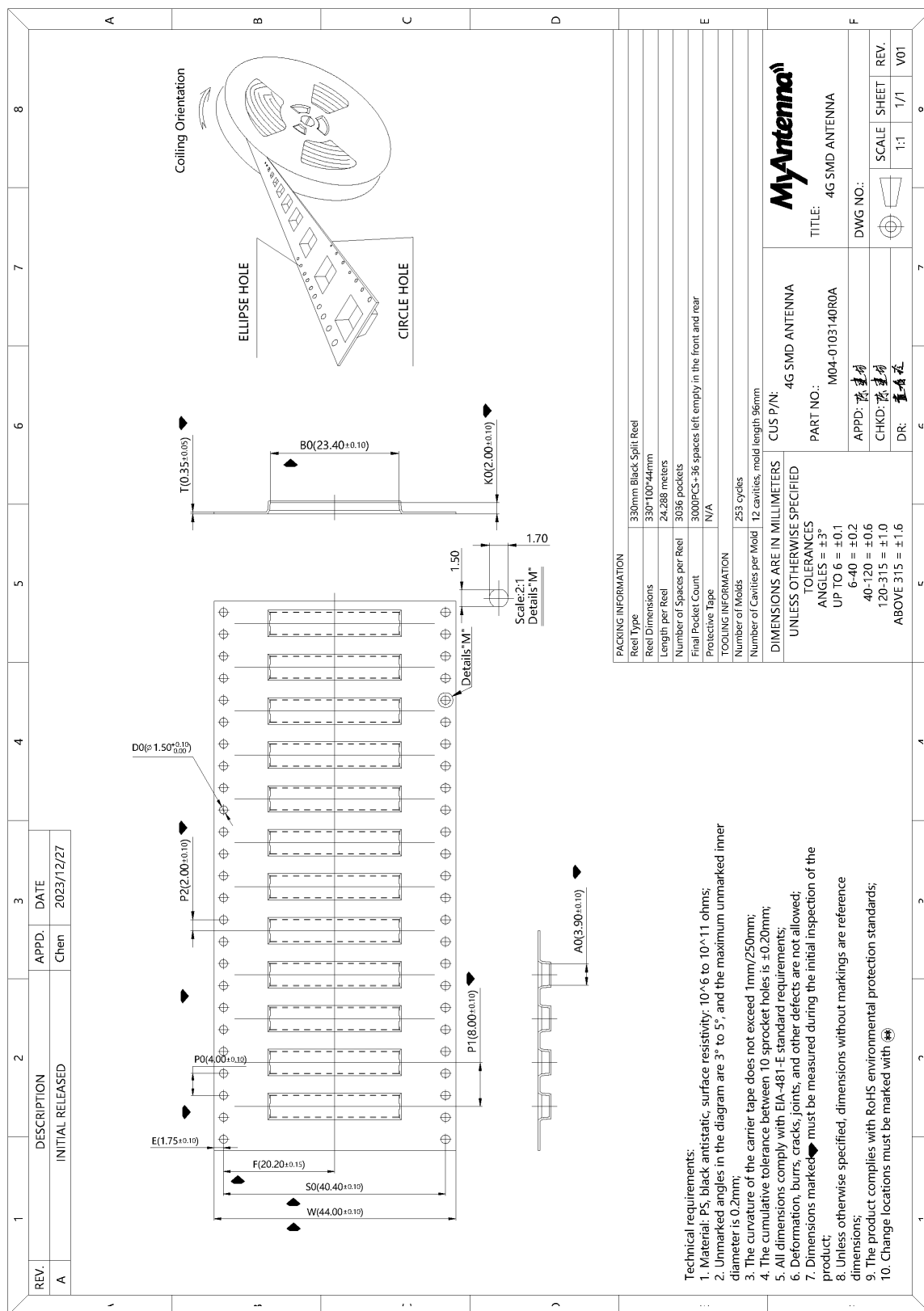



www.aboosty.com

The materials provided herein, which are intended for illustration purposes only, are believed to be reliable and correct. However, no responsibility is further assumed for inaccuracies or incompleteness, and all such information shall be entirely at the user's risk. All information is subject to change without prior notice.

Copyright © 2023 ShenZhen MyAntenna RF Technology Co., Ltd. All Rights Reserved.