

EVALUATION BOARD FOR

4G, LORA SMD ANTENNA

   698-960 MHz | 1710-2690 MHz

Dimensions: 150 x 50 x 1.6 mm

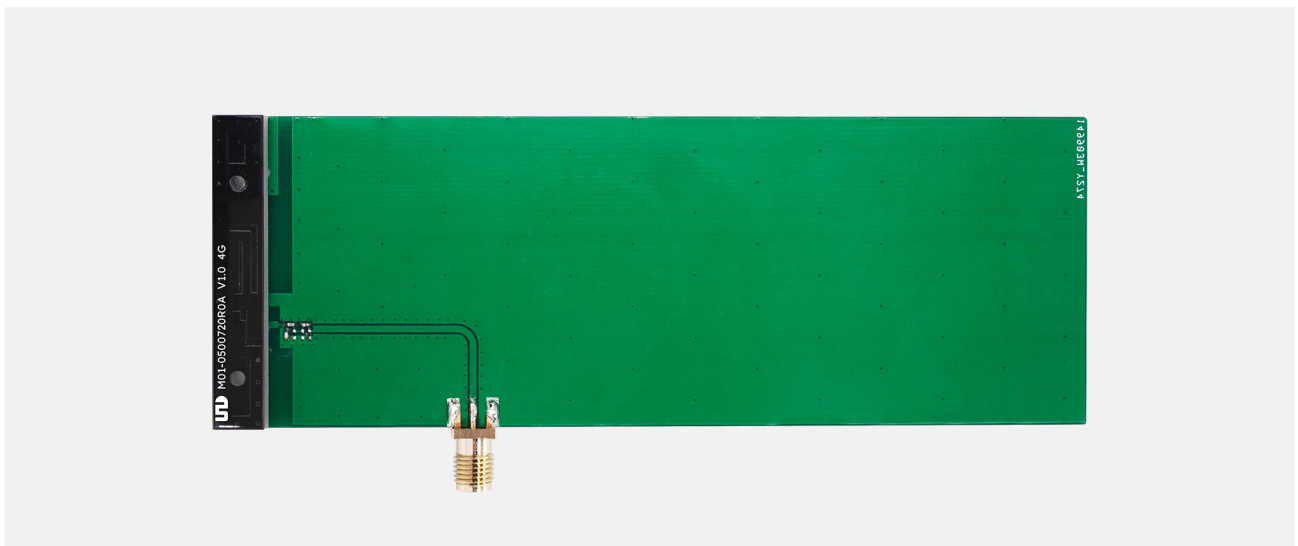

PN: M07-0100050R0A





Table of Contents

1 FEATURES & BENEFITS	1
2 APPLICATIONS.....	1
3 ORDER INFORMATION.....	1
4 EVALUATION BOARD	1
5 REFERENCE GUIDE.....	2
6 MATCHING NETWORK.....	3
7 RECOMMENDED FOOTPRINT AND LAYOUT	3
8 ELECTRICAL PERFORMANCE	5
8.1 VSWR and Total Efficiency	5
8.2 Radiation Patterns (698-960 MHz), Efficiency (%) and Gain (dBi).....	6
8.3 Radiation Patterns (1710-2690 MHz), Efficiency (%) and Gain (dBi).....	7
9 SOLDERING CONDITIONS.....	8
10 ANTENNA CERTIFICATION	8
11 WELCOME ALL ANTENNA OEM/ODM PROJECTS	9

www.aboosty.com

The materials provided herein, which are intended for illustration purposes only, are believed to be reliable and correct. However, no responsibility is further assumed for inaccuracies or incompleteness, and all such information shall be entirely at the user's risk. All information is subject to change without prior notice.

Copyright © 2024 ShenZhen MyAntenna RF Technology Co., Ltd. All Rights Reserved.



1 FEATURES & BENEFITS

- Compact Size
- Light Weight
- Easy to Integrate
- Intended for SMD Mounting
- Reduced Cost and Time-to-Market

2 APPLICATIONS

- Home Automation
- Wireless Routers and Modems
- Internet of Things (IoT) Devices, M2M
- Remote Technology / Monitoring
- Consumer Tracking
- Smart Metering

3 ORDER INFORMATION

Product Name	Evaluation Board for 4G, LoRa SMD Antenna
Part Number	M07-0100050R0A
Dimensions	150 x 50 x 1.6 mm
Weight	27.1 g
Mounting	SMT
For Use With	ADCP001

4 EVALUATION BOARD

The evaluation board provides operation at 698-960, 1710-2690 MHz.
Evaluation Board dimension: 150 x 50 x 1.6 mm





5 REFERENCE GUIDE

Technical Features	698-960 MHz	1710-2690 MHz
Max VSWR	6.9:1	2.5:1
Max Efficiency	78.9%	
Max Return Loss	-2.7 dB	
Peak Gain	Up to 3.01 dBi (Typ)	
Max Input Power	2 Watts CW	
Polarization	Linear	
Input Impedance	50 Ω	
Operating Temperature	-40°C to +80°C	
Relative Humidity	10 to 70%	
Board Dimensions (L x W x H)	150 x 50 x 1.6 mm	

All data were measured with an antenna of 49.6 mm length, 8.0 mm width, and 3.2 mm thickness. Application data might vary.

6 MATCHING NETWORK

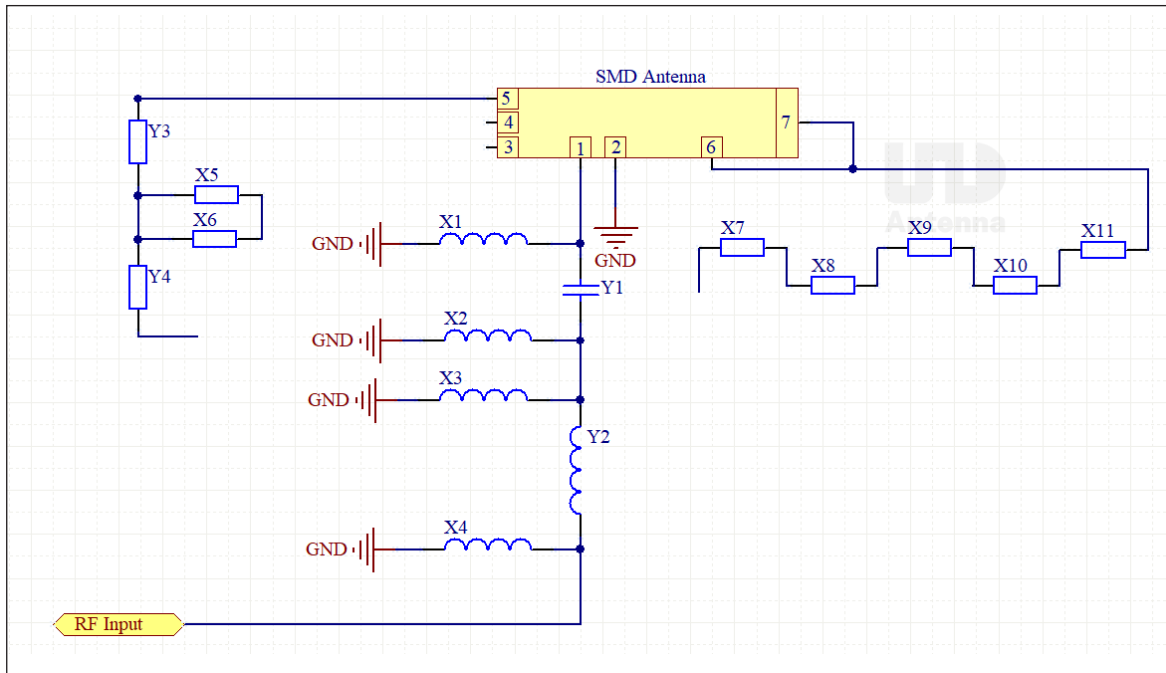

7 RECOMMENDED FOOTPRINT AND LAYOUT

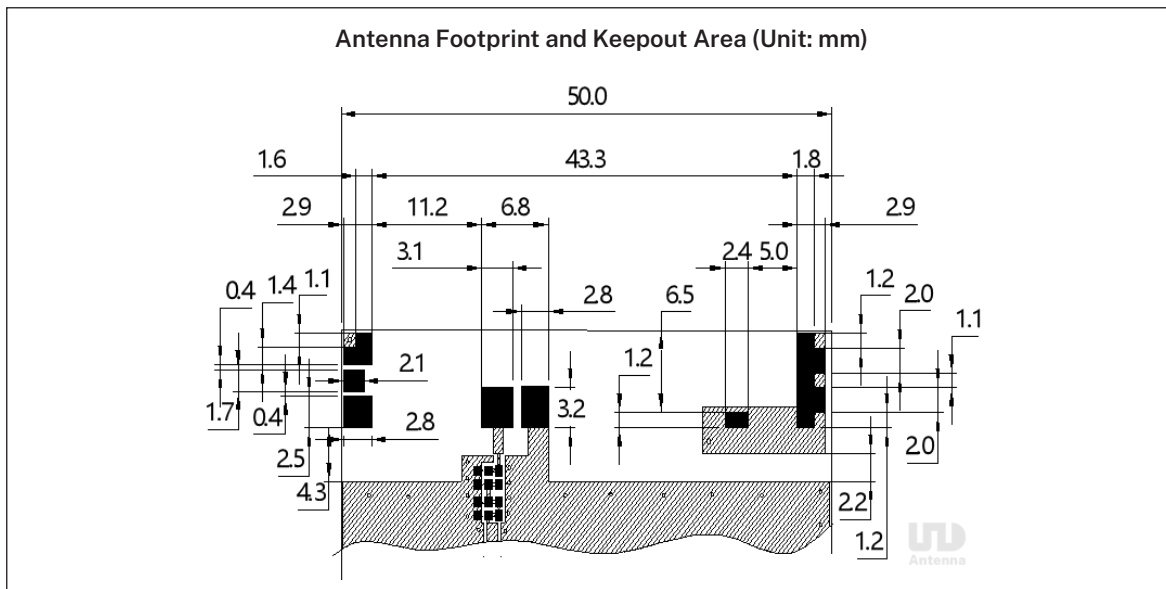

It's strongly recommended to place the antenna near the edge of the board. Maximum antenna performance is achieved by placing the antenna towards one of the corners of the PCB and with the feed point of the antenna as close to same corner of the PCB as possible.

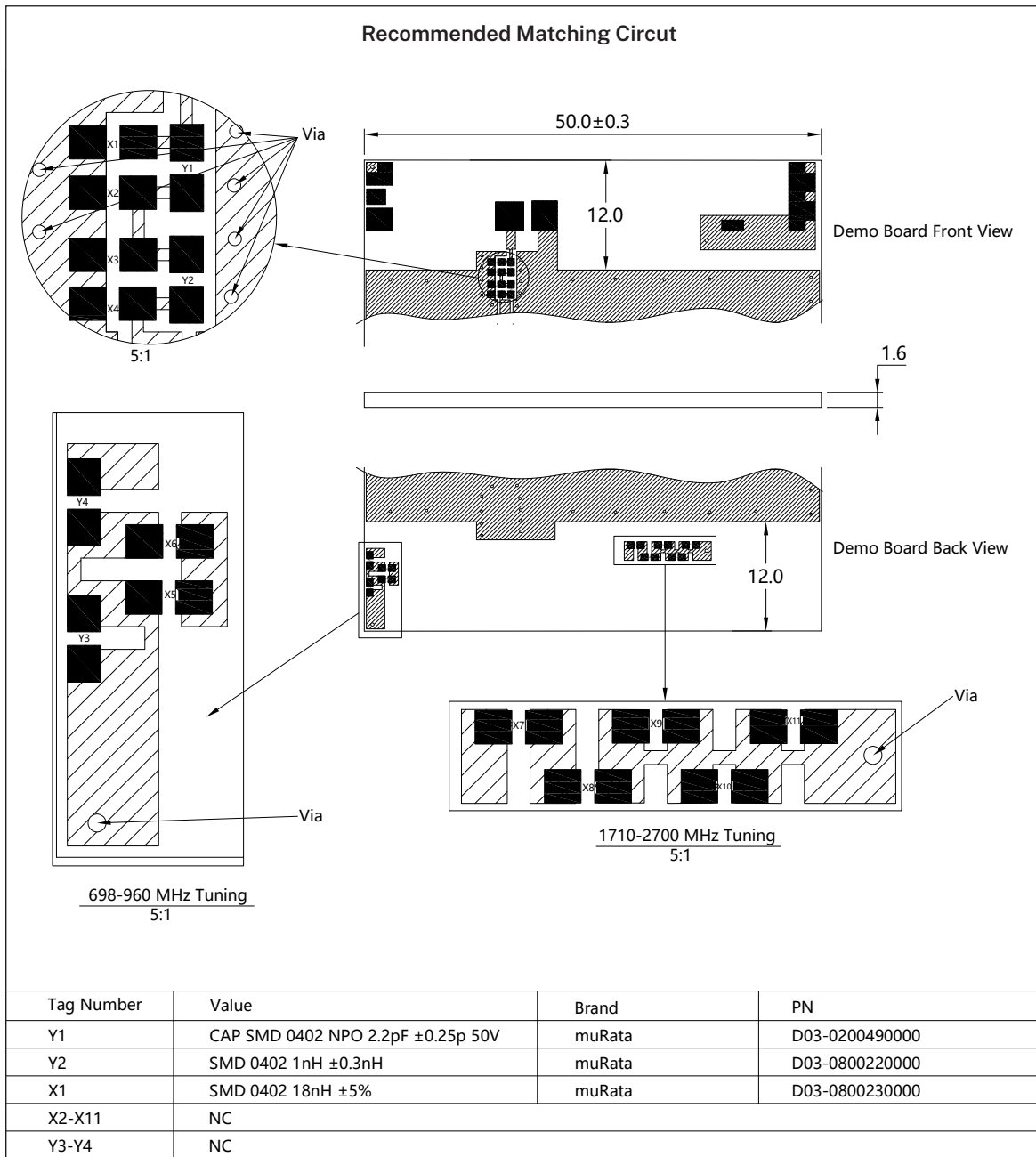

8 ELECTRICAL PERFORMANCE

© Note

All data displayed in Chapter 8 were measured with Antenna ADCP001 and on a reference ground plane of 150 mm length, 50 mm width, and 1.6 mm thickness.

8.1 VSWR and Total Efficiency

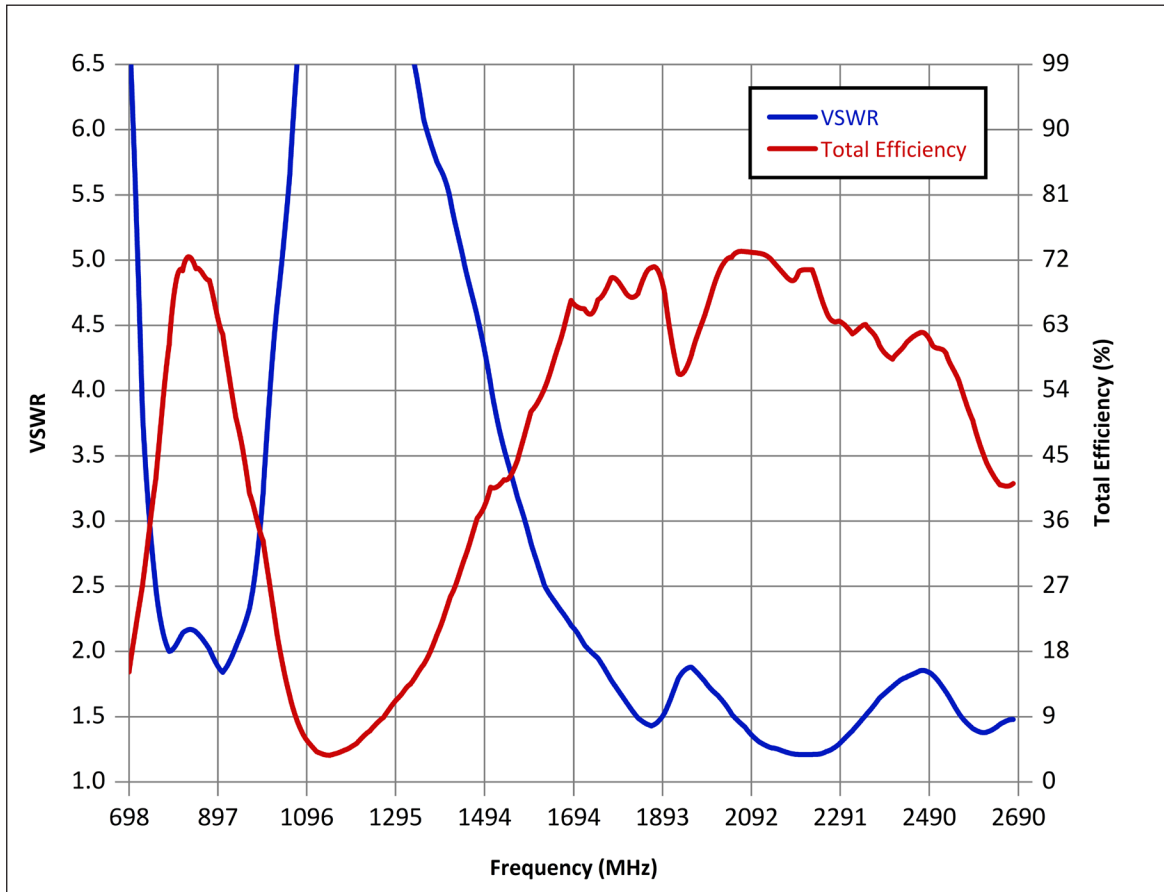

8.2 Radiation Patterns (698-960 MHz), Efficiency (%) and Gain (dBi)

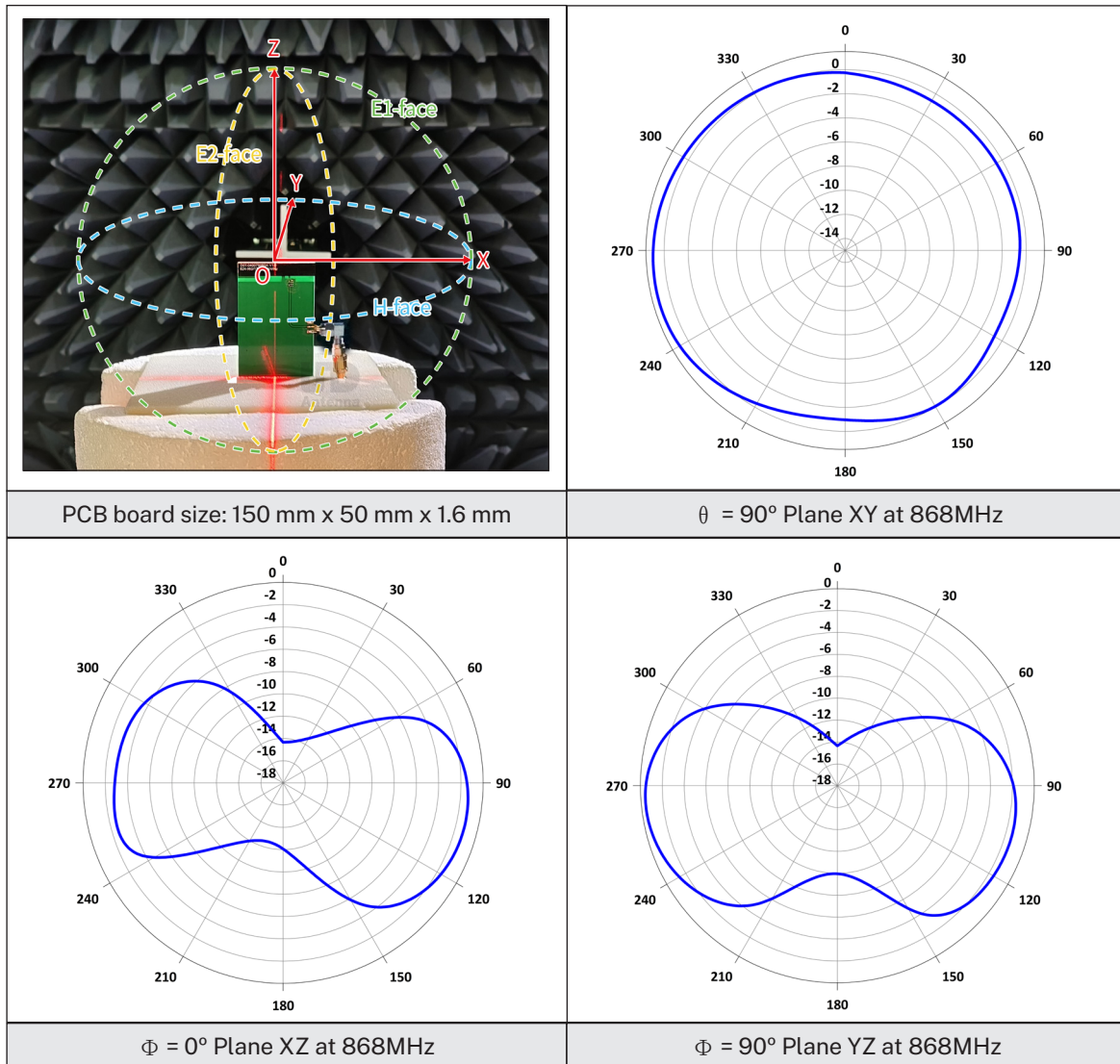

Gain	Peak Gain	1.2 dBi
	Average Gain across the band	-0.4 dBi
	Gain Range across the band (min, max)	-7.2 to 1.2 dBi
Efficiency	Peak Efficiency	73.5%
	Average Efficiency across the band	53.4%
	Efficiency Range across the band (min, max)	15.2 to 73.5%

8.3 Radiation Patterns (1710-2690 MHz), Efficiency (%) and Gain (dBi)

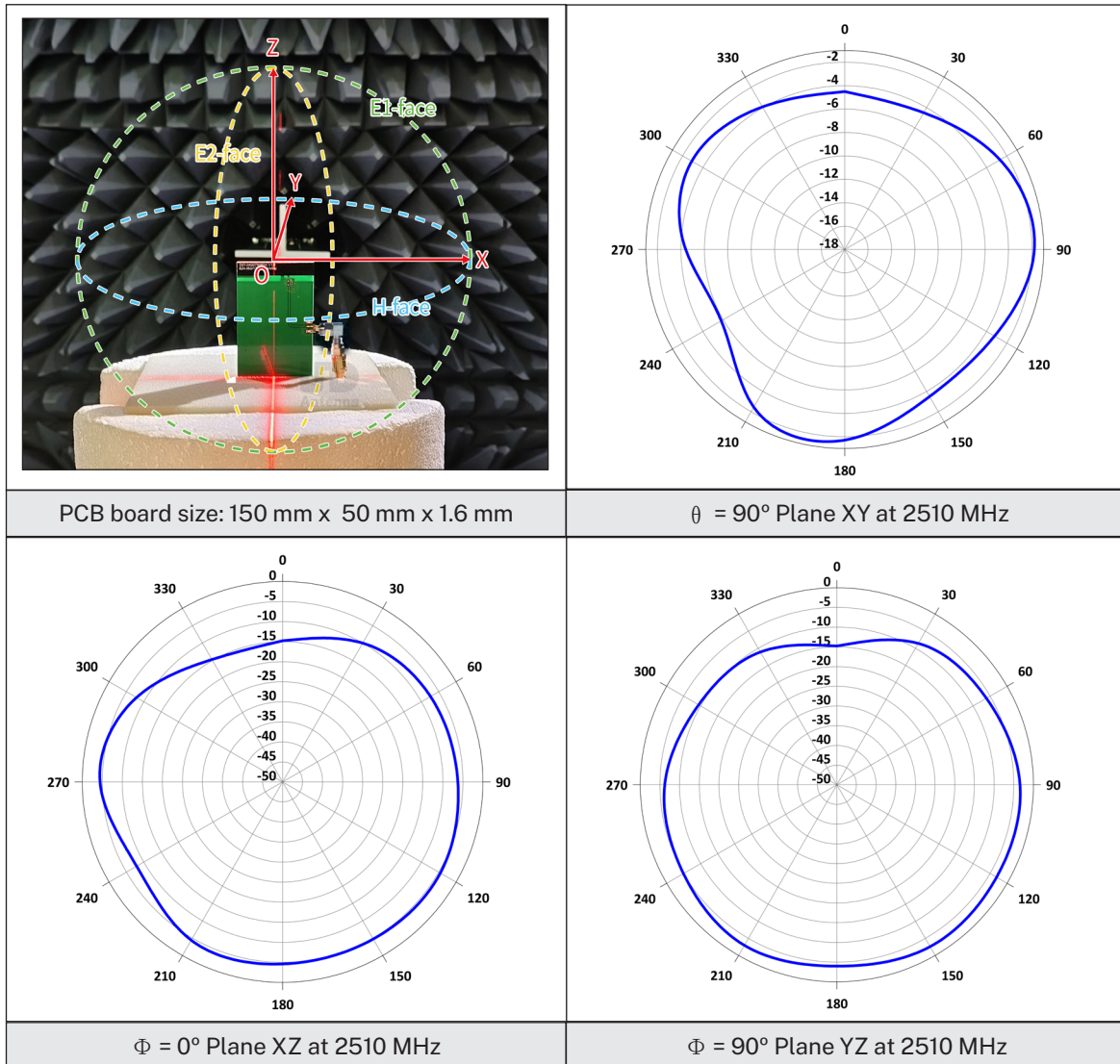

Gain	Peak Gain	3.0 dBi
	Average Gain across the band	1.5 dBi
	Gain Range across the band (min, max)	-0.01-3.0 dBi
Efficiency	Peak Efficiency	78.9%
	Average Efficiency across the band	62.6%
	Efficiency Range across the band (min, max)	35.2 to 78.9%

9 SOLDERING CONDITIONS

This antenna is suitable for lead free soldering.

The reflow duration should be adjusted to create good solder joints without raising the antenna temperature beyond the allowed maximum of 260°C.

The figure below shows the temperature profile for soldering.

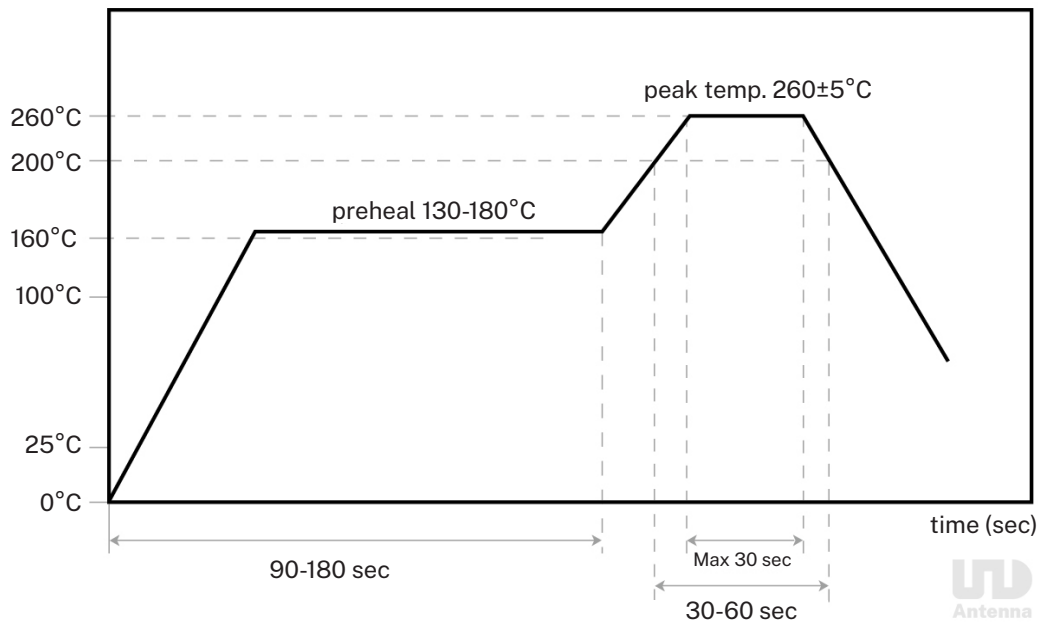

10 ANTENNA CERTIFICATION

RoHS Approval	Compliant [2011/65/EU&2015/863]
REACH Approval	Conform or declared [(EC)1907/2006]
Hazardous material regulation conformance: A certificate of conformance is available upon request. Feel free to consult us for details.	



11 WELCOME ALL ANTENNA OEM/ODM PROJECTS

About ABOOSTY



10+ years in antenna R&D, production, and OEM/ODM



House of Aboosty: 50M+ units annual output capacity



Factory directly competitive price



Industry-leading quality levels



Professional team-work & support



Quick price and lead time estimation

Why Choose ABOOSTY



Innovative and patented design solutions



Full terminal devices anechoic chamber test



Co-location with its custom



Competitive price



Strict inspection



Prompt reply within 24h

What We Provide

OEM/ODM Services	
Light Customization	Deep Customization
<ul style="list-style-type: none"> • Logo • Packaging • Cables&Connectors 	<ul style="list-style-type: none"> • In-depth tailoring for specific applications • Functional enhancements • Environmental adaptations • Vertical certifications • ...

Custom Process

Light Customization Process

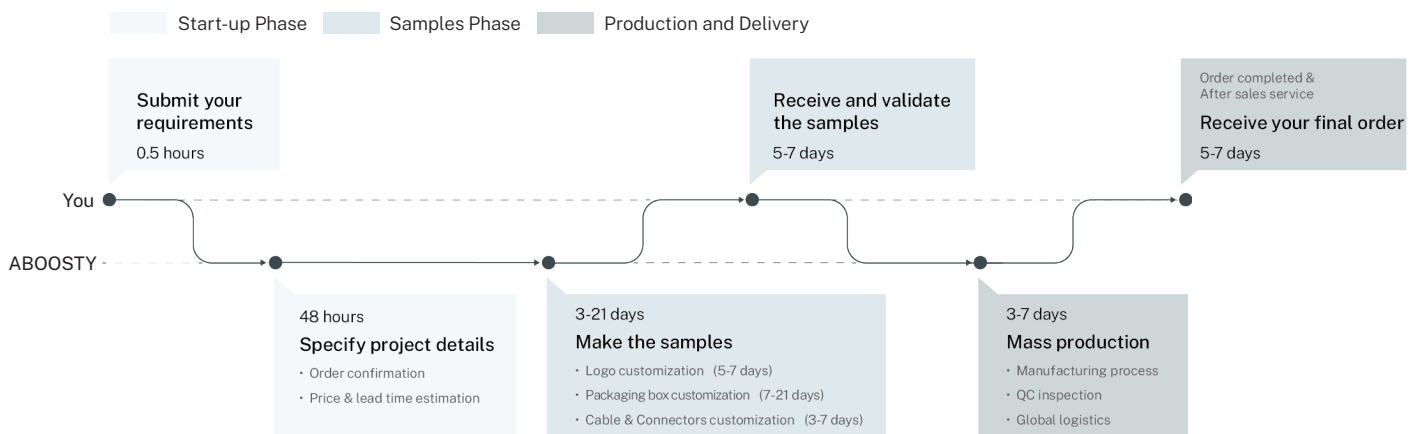



Deep Customization Process

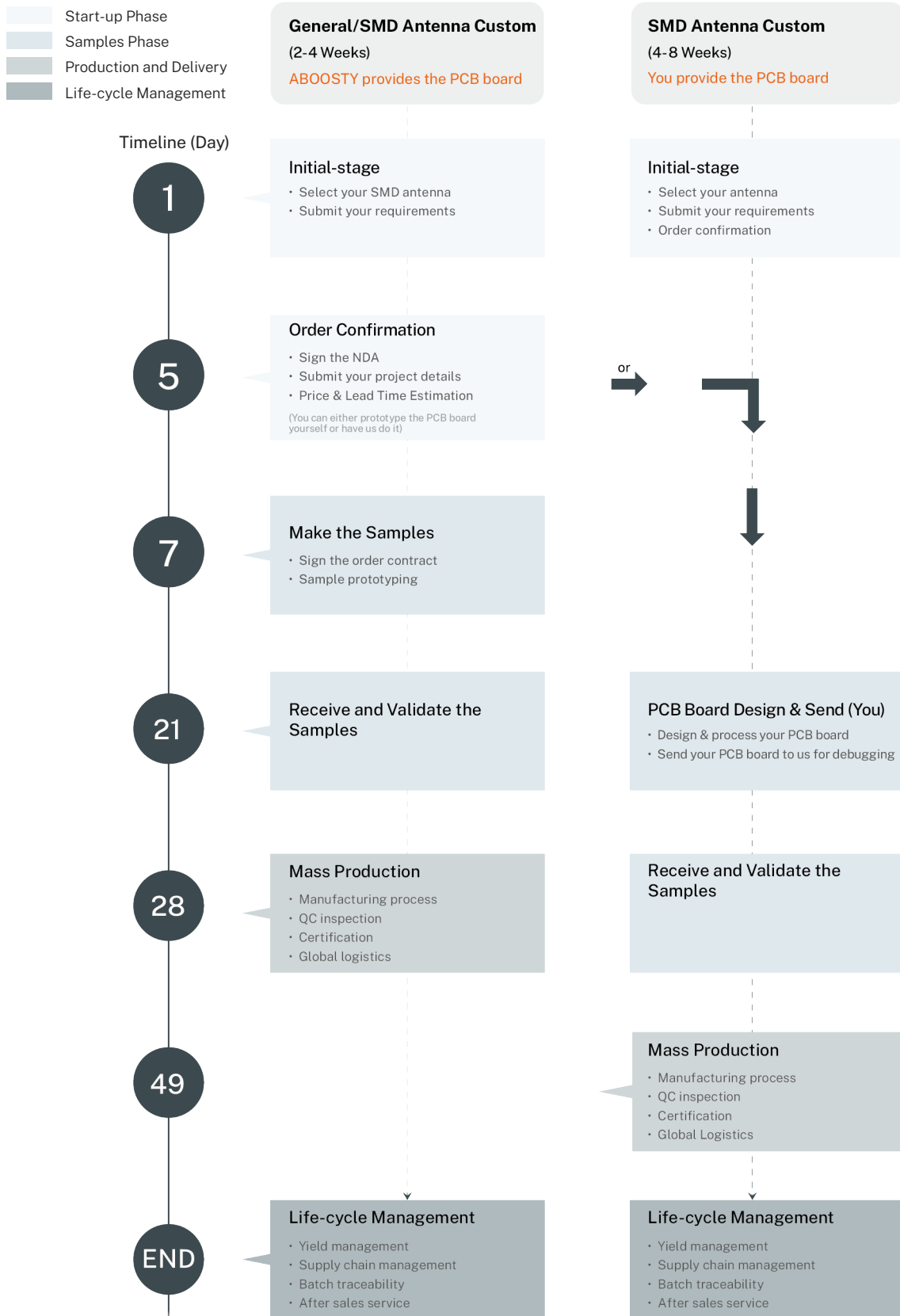

ABOOSTY

A Globally Leading Manufacturer and Supplier of
Multi-band Combination Antennas

Visit us at www.aboosty.com

✉ support@aboosty.com 📞 +86 13924678201

